

Photovoltaic Grid Connected System for Small Food Kiosk.

O. Sadmai and S. Hiranvarodom

Abstract— This paper proposes the design and installation of PV grid connected for small food kiosk that has been installed in The Rajamangala University of Technology Thanyaburi in Prathumthani province. This paper consist of The computer program simulation [1] and actual installation by install PV panel on the roof of small food kiosk, the main objective is reduced electrical energy consumption, The small food kiosk have several load such as refrigerator, rice cooker, fluorescent lamp and more. Before installation of PV grid connected system, the design and simulation have been done first by computer program. The PV system has designed a single phase system which a single inverter and there are 6 PV panels type mono crystalline silicon. The actual installation has shown the electrical data which can be read from grid connected inverter. Accordingly, 5 month after installation, it shows the PV system can be produced 3.9 units per day at maximum points and average 3 units per day.

Keywords— PV, Grid Connected, Small food kiosk.

1. INTRODUCTION

In the Thailand University, the Rajamangala University of Technology Thanyaburi (RMUTT) [2] is the one of nine universities that has been separated from Rajamangala institute of technology (RIT) after has been established as a Rajamangala University of Technology (RMUT). The faculty of engineering has been developed the green energy by supporting all sustainable energy such as solar energy, wind turbine, fuel cell and energy from waste. The dean of engineering is the one of all executives has policy to reduce electrical consumption in the university. The small food kiosk has been selected to install a single phase grid connected PV system that there are a single inverter and 160 Watt PV panels are to be installed on the roof of the small food kiosk.

2. SIMULATION AND ANALYSIS OF SYSTEM

The simulation program is called “HOMER” is to be selected to analyze all data that can be shown in the system. From the figure 1, it shows a model of a single phase PV system. The PV system is modified to 1.05 kW_p and converter is a grid connected inverter.

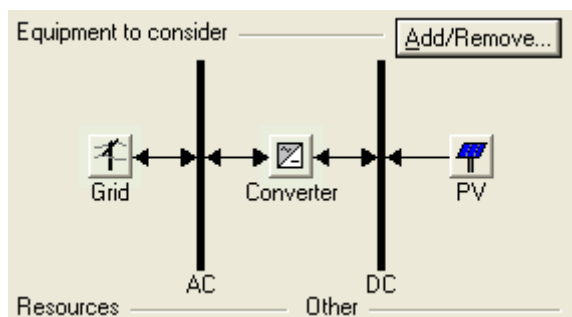

Figure 1. The simulation system used in this work.

Table I. Simulation output program

Quantity	Value	Units
Rated capacity	1.05	kW
Mean output	0.16	kW
Energy output	3.96	kWh/d
Capacity factor	15.7	%
Total production	1,445	kWh/yr

As can be seen from the table 1, it shows the result of the system such as mean output 160 watt, energy output and total production. From the resulting, the PV system can be produced electrical energy and it has been supporting to the load is about 3.96 units per day. This data is one of important input data for the process of simulation.

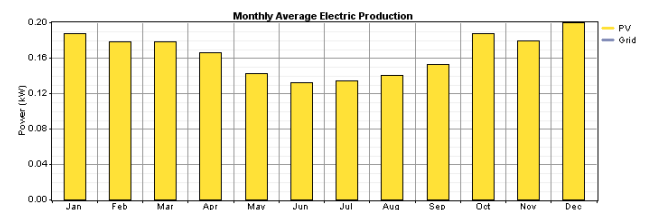

Figure 2. Power output of PVside

As can be seen from the figure 2, it shows the monthly average power of PV system. On January, the system has average power is 180 watt maximum and minimum in June.

From the figure 3. It shows the power of PV system in all month of the year. It has very good power on January to March and September to December. Accordingly, the inverter output and inverter input can be shown in the figure 4.

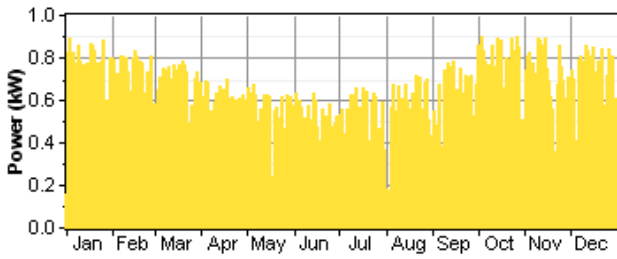

Figure 3. The power of PV system

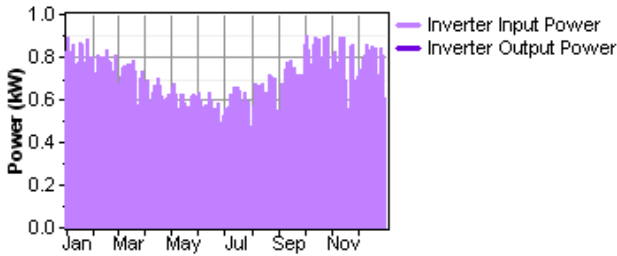

Figure 4. The inverter input and output power

3. INSTALLATION

As can be seen in the figure 5, it shows the small food kiosk that has been installed PV panels on the roof of the small food kiosk. There are 6 PV panels that has sizing is $160 W_p$ per panel.



Figure 5. Installation of photovoltaic system at the roof of small food kiosk

As can be seen in the figure 6, it shows the beside of small food kiosk that has installed PV panels on the roof of small food kiosk.

As can be seen in the figure 7, it shows the energy meter and grid connected inverter on site that has been stalled PV system. The grid connected inverter has been received the electrical data such as voltages, current, power and all useful data for analysis. The energy meter has been stored electrical energy from AC load, AC grid and PV energy is distributed from grid inverter.



Figure 6. Beside of small food kiosk.



Figure 7. Grid connected inverter and energy meter.

Table II. Specification of PV array.

PV panel BP 365		
Maximum power.	175	W
Maximum voltages.	35.4	V
Maximum currents.	4.94	A
Open circuit voltages.	43.6	V
Short circuit currents.	5.45	A

Table III. Specification of Grid connected inverter.

Grid connected inverter- Apollo G-300		
Power output	2500	W
DC voltages	165 - 300	V
AC voltages	200 - 240	V
Frequencies	50-60 +- 5%	H _z

4. EXPERIMENTAL RESULT

All of this figures are to be shown the result of the system when the system has installed more than 5 month.

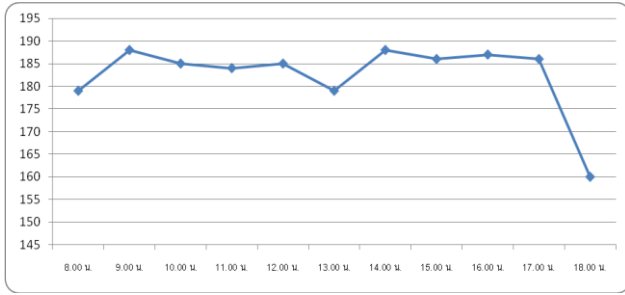

Figure 8. DC voltage of PV system

In the figure 8, it shows the dc voltages of the PV system. It can be measured at 14.00 pm about 188 volts and at 18.00 pm. The DC voltages have been decreasing to zero voltages. In fact, the dc voltages have been constant voltage because the dc voltage has not been changed during day that different from the DC current, it has been affected by solar radiation and cloud.

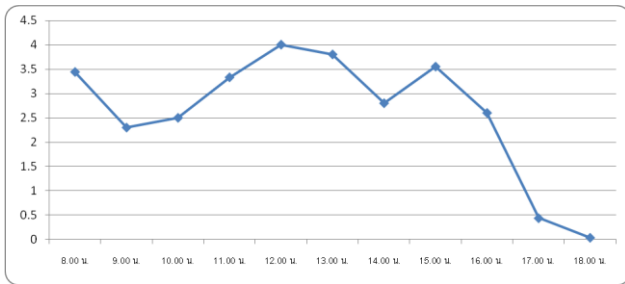

Figure 9. The current of the PV system

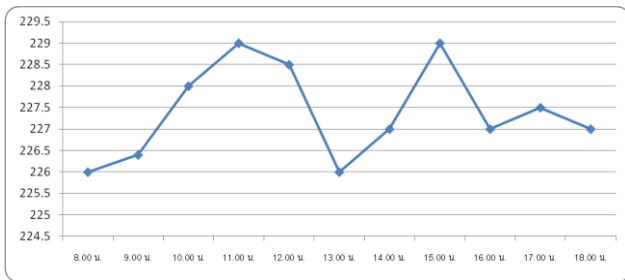

Figure 10. AC voltages of the grid connected inverter

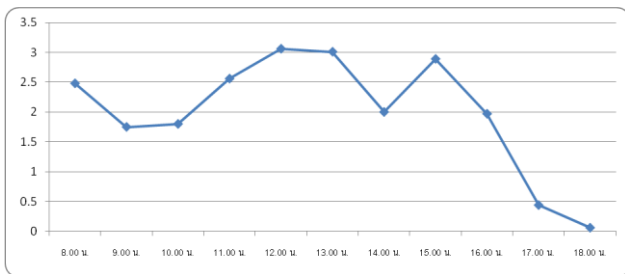

Figure 11. AC current of the grid connected inverter

As can be seen in the figure 8, 9 it shows the ac voltage and ac current that have been measured from the grid connected inverter.

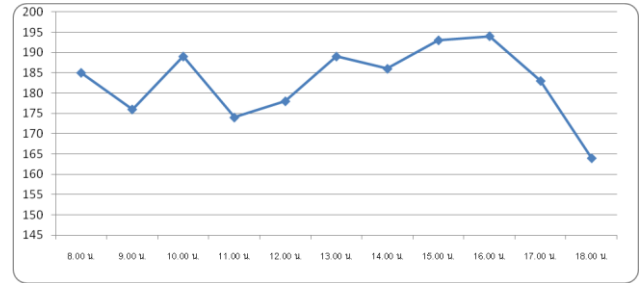

Figure 12. Average DC current of PV panel

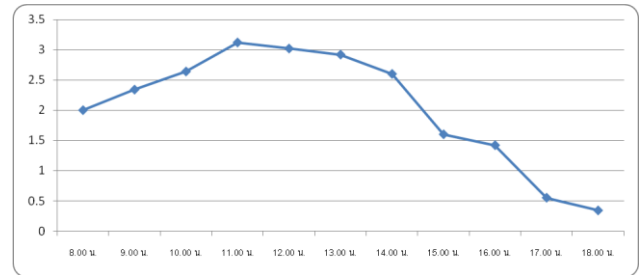

Figure 13. Average DC current of PV panel

As can be seen in the figure 14, it shows the average AC voltage that has been measured from the grid connected inverter by 5 month. The minimum of AC voltage was to be shown about 225 volts at 8.00 am. and maximum at 11.00 am. and 16.00 pm. Respectively.

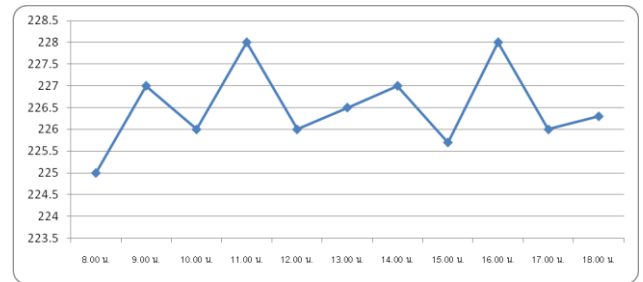

Figure 14. Average AC voltage of the inverter

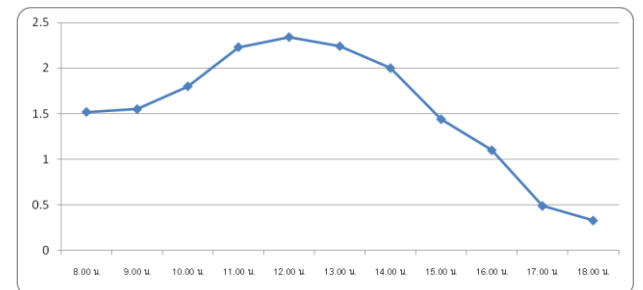

Figure 15. Average AC current of the inverter

From the figure15, it shows the average ac current from the inverter which can be distributed current to the load and it can be produced current nearly 2.5 amperes.

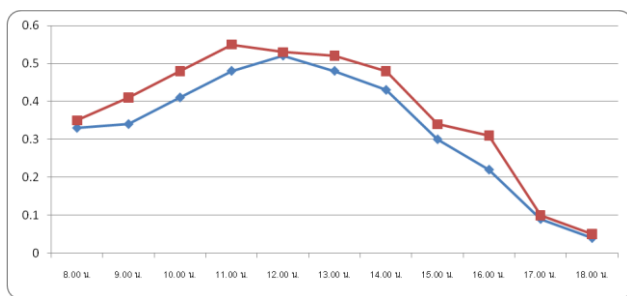

Figure 16. Average power of PV system and AC grid connected inverter

As can be seen from the figure 16, it shows the ac power and dc power of the PV system. Moreover, the PV system has been forced by the environment of area. It had installed under the big trees. In the afternoon, the sky over the system not opened. So, the power of the system in the afternoon has low power which compared by in the morning. It can be shown by figure16.

5. CONCLUSION

This paper proposes the design and installation of PV grid connected for small food kiosk that has been installed in The Rajamangala University of Technology Thanyaburi in Prathumthani province. This paper consist of The computer program simulation and actual installation by install PV panel on the roof of small food kiosk, the main objective is reduced electrical energy consumption, The small food kiosk have several load such as refrigerator, rice cooker, fluorescent lamp and more. Before installation of PV grid connected system, the design and simulation have been done first by computer program. The PV system has designed a single phase system which a single inverter and there are 6 PV panels type mono crystalline silicon. The actual installation has shown the electrical data which can be read from grid connected inverter. Accordingly, 5 month after installation, it shows the PV system can be produced 3.9 units per day at maximum points and average 3 units per day. The energy consumption of small food kiosk's load is to be reduced by PV system. The energy of the system from the results of simulation is about 3.96 units per day. Furthermore, a practical installation of PV system with grid connected system has been success. Accordingly, the simulation and practical installation have shown good idea to analysis. For this research will have been continuing to keep the electrical energy and more.

6. ACKNOWLEDGEMENT

The authors would like to thank all staff at the department of electrical engineering, faculty of engineering Rajamangala University of Technology Thanyaburi (RMUTT) for providing a useful information and discussion in this research work.

7. REFERENCES

- [1] National Renewable Energy Laboratory, "Getting Started Guide for Homer Version 2.1" <http://www.nrel.gov/homer>.
- [2] Adder <http://www.pea.co.th/vspp/>
- [3] Faculty of Electrical Engineering Department, Rajamangala University of Technology Thanyaburi <http://www.rmutt.ac.th>
- [4] Photovoltaic in buildings Design A Design Guide Report No.ETSU/P2/00282/REP (March 1999)
- [5] O.Sadmai, S.Hiranvarodom 2010. System Performance Analysis of 10 kWp Photovoltaic System Grid Connected Type Installed at a Thai University In *Proceeding of renewable energy 2010 conference*. Yokohama , Japan , 27 June – 2 July. Pacifico Yokohama.